

## ASSEMBLY INSTRUCTIONS

READ ALL INSTRUCTIONS BEFORE YOU BEGIN. PLEASE FOLLOW THE STEPS IN ORDER.

### PARTS LIST:

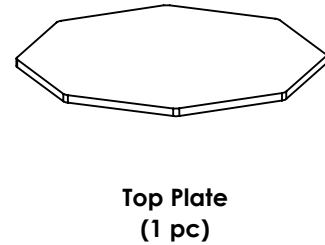
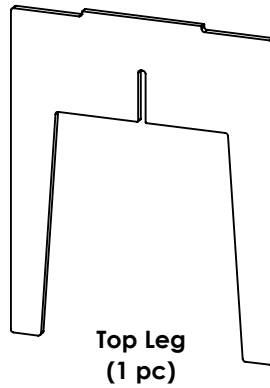
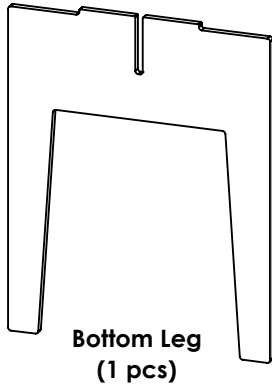

**STEP 1:** Position the center of the Top Leg over the center of the Bottom Leg and align the center slots for engagement. Slide the Top Leg slot into the Bottom Leg slot with a downward force until it stops.

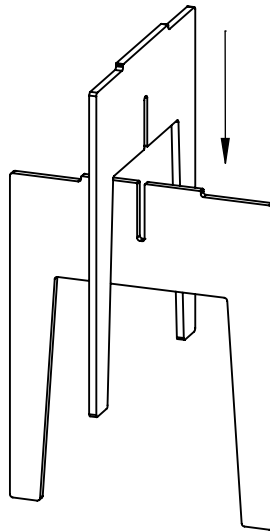

**STEP 2:** The connection between the Top Leg & the Bottom Leg should be snug and all four feet should be touching the ground.

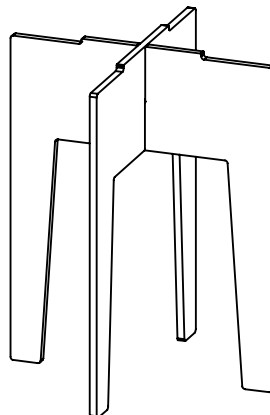

## ASSEMBLY INSTRUCTIONS

**READ ALL INSTRUCTIONS BEFORE YOU BEGIN. PLEASE FOLLOW THE STEPS IN ORDER.**

**STEP 3:** Align the cross groove on the bottom face of the Top Plate with the top tabs of the Bottom Leg & Top Leg.

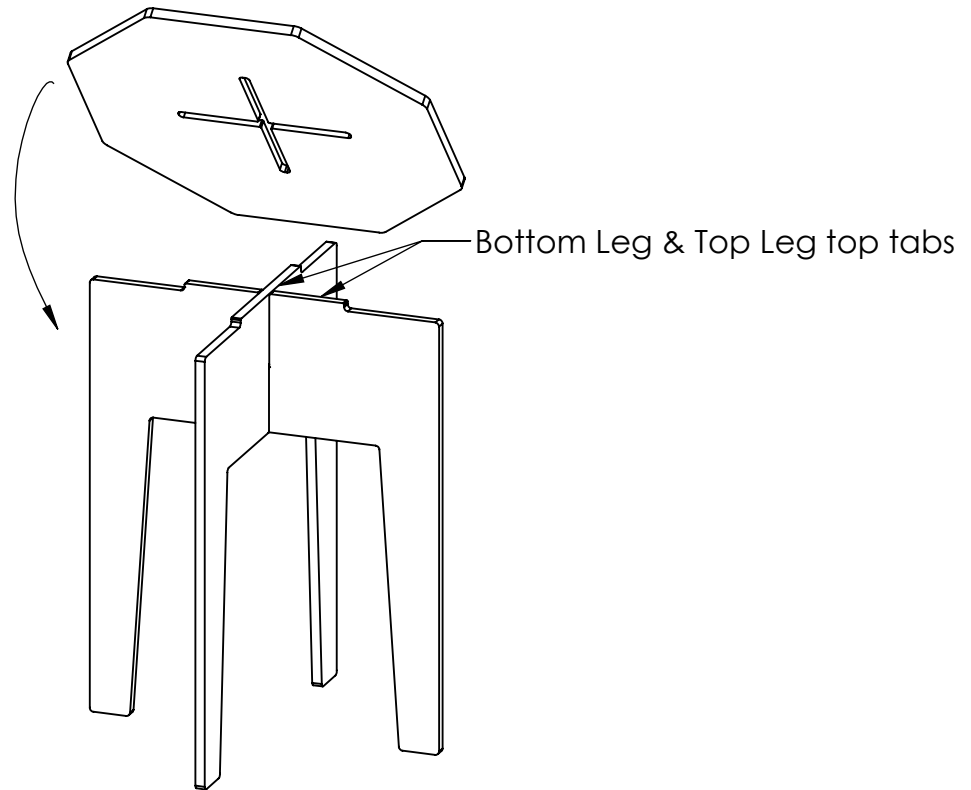

**STEP 4:** The connection between the Top Plate & the Legs should be snug. The Top Plate should lay level & flat.

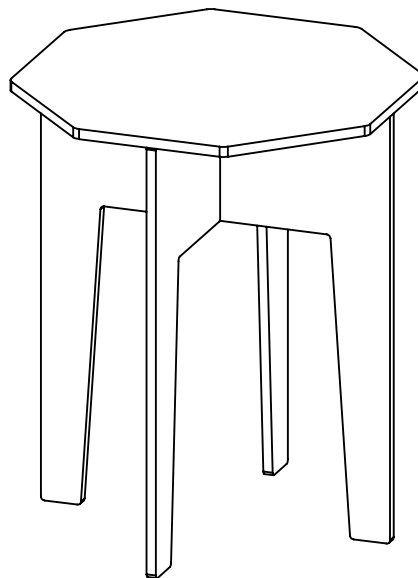

ASSEMBLED OCTAGONAL SIDE TABLE